

# Disco 240

## Scanner control console

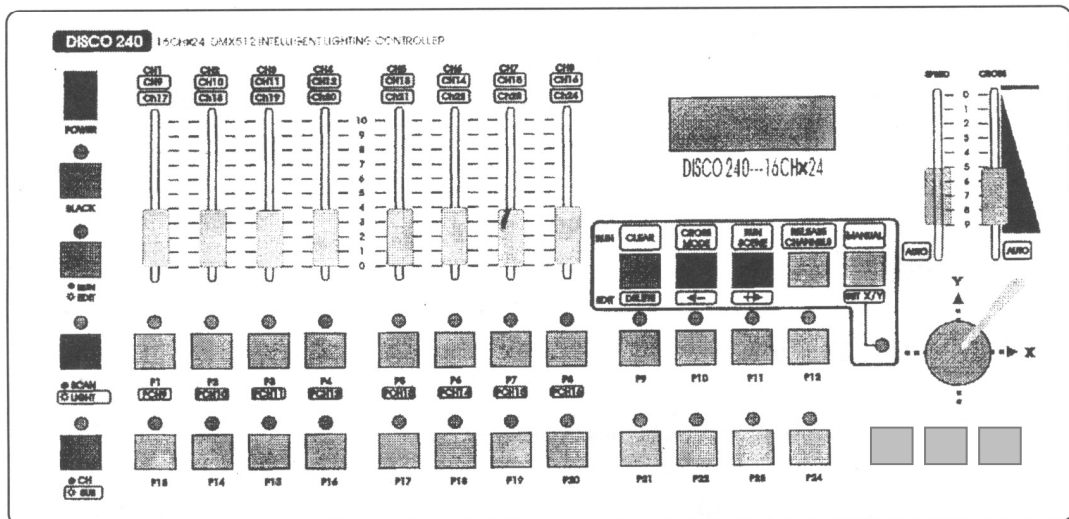

## User's Manual

# Table of contents

1. Parameters.....	1
2. Safety use cautions.....	2
3. Contents in the package.....	2
4. Communication cable.....	2
5. DMX512 address distribution.....	3
6. Diagram of the communication cable link and scanner address set.....	4
7. Diagram of the panel and functional areas.....	5
8. Explanation of functional area of the panel.....	5
9. Explanation of the duplex key area.....	7
10. Explanation of the display information on the LCD.....	8
11. The editing of scanner chase.....	9
12. Running of scanner chases.....	10
13. Special scene presentation.....	10
14. How to set and cancel the joystick potentiometer.....	11
15. Conventional dimmer control.....	11

Thanks for using Disco240 scanner console! Disco240 console has internationally standard DMX512 signal output. Before operation, please refer to the user's manual carefully.

## 1. Parameters

Output signal specifications	DMX512 international standard
Total number of channels	192 channels
Number of scanners	24 scanner
Max. number of channels for the scanner	16
Number of chases(scenes)	12 chase
Maximal number of chase steps(scene)	40 steps
Total number of chase steps(scene)	480 steps
Scene pause time	0.1-25.5 second/step
Scene cross speed	0.1-25.5 seconds
Dimmer channel	24 channels
Display screen	LCD display, 16×2 characters
DMX512 outputs interface	3-core XLR pin socket and socket
Memory capacity	128 K high capacity memory card
Input voltage	50 / 60HZ—5V / 2000MA
Volume	483mm×178mm× <b>80mm</b>
Weight	3.25Kg

## 2. Safety use cautions

- The console must be connected to the safety earth line.
- Never pulling out or inserting the communication cable with electricity.
- Start order:Please turn on all the controlled scanner power supplies first,and then turn on the controller power,otherwise the controller is easy to be destroyed.
- Prevent it from damp,water,dust, static, and maintain and clean it regularly.

## 3. Contents in the package

- Disco240 console 1
- DMX512 cable 1
- Disco240 user's manual 1
- Power adapter 1

## 4. Communication cable

- It adopts the twisted screened wire with the specified impedance of 120 ohms, and if the cable exceeds 200 meters long or there are too many scanners, a signal amplifier should be added, and a terminal resistor should be added to the last scanner(120ohms/1W).
- The Pin 1 of the communication cable is the grouding (GND), Pin 2 is negative signal, and Pin 3 is positive signal; they should not be inversely connected, and should not be coldly welded.
- The communication cable should be screened by single-terminal earthing.
- The communication cable should not be wired together with strong electricity.

## 5. DMX512 address distribution

Disco240 console uses 1 to 240 channels of DMX512, so it can control the scanners with no more than 16 channels. The address is distributed as follows:

Scanner serial number	Scanner DMX starting address	
	When using Disco240	
	Decimal system	Scanner address switch location
1	1	1 ON
2	17	1,5 ON
3	33	1,6 ON
4	49	1,5,6 ON
5	65	1,7 ON
6	81	1,5,7 ON
7	97	1,6,7 ON
8	113	1,5,6,7 ON
9	129	1,8 ON
10	145	1,5,8 ON
11	161	1,6,8 ON
12	177	1,5,6,8 ON
P13-P24	206-217	
Dimmer channel 1-24	218-241	

The DMX512 channel distribution of Disco240

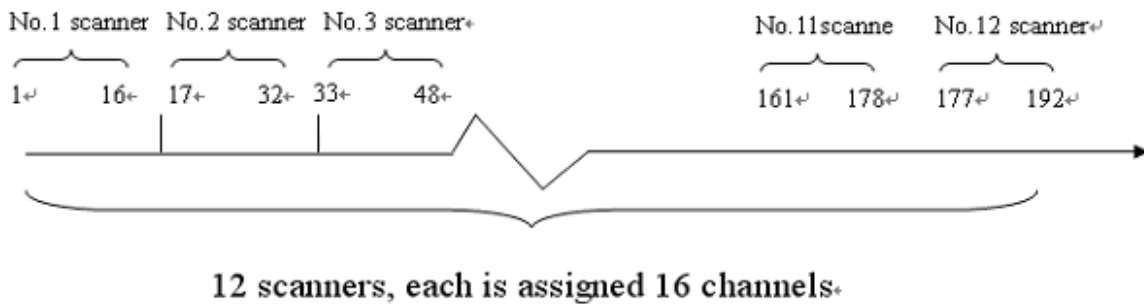

# 6. Diagram of the communication cable link and scanner address dial

Terminal resistance: 120ohms/1W

## Disco 240 Scanner control console

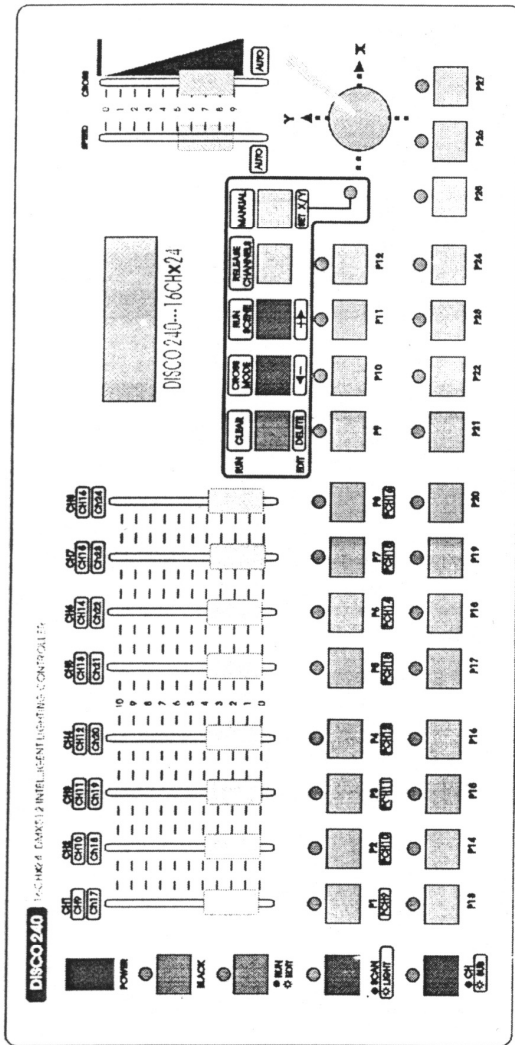

### No.12 Scanner:



### No.8 Scanner:



### No.7 Scanner:



### No.6 Scanner:

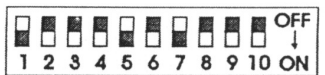

### No.5 Scanner:

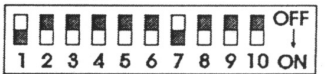

### No.4 Scanner:

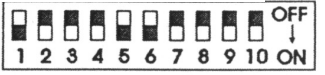

### No.3 Scanner:

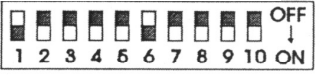

### No.2 Scanner:

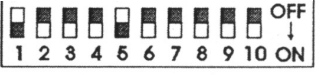

### No.1Scanner:

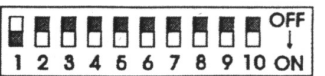

## 7. Diagram of the panel and functional areas

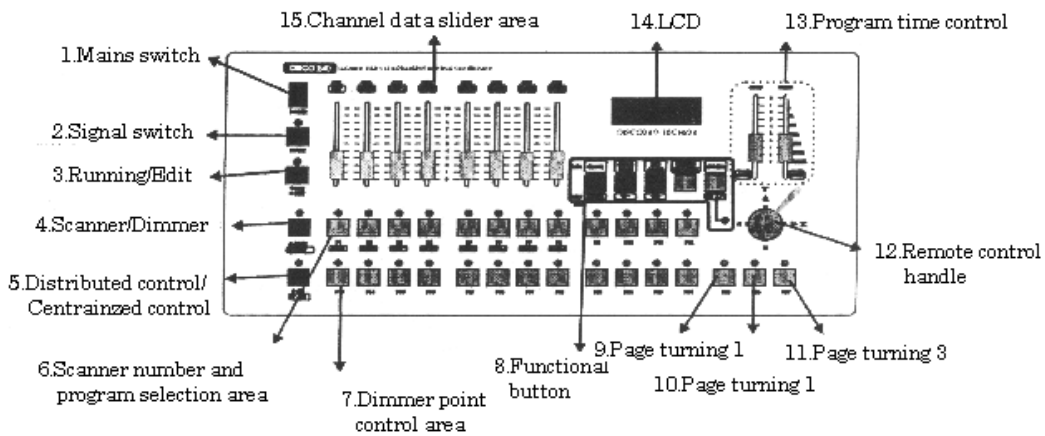

## 8. Explanation of functional area of the panel

Serial Numbe	Name description	Function explanation
1	POWER	Controller internal mains switch; if the power supply of the whole machine needs to be turned off , please pull out the external power adaptor.
2	BLACK	<b>Change the light converting and operation state</b> ◆ <b>LED is on:</b> light converting,all the output DMX signals are 0. ◆ <b>LED is off:</b> Normal signal output state.
3	EDIT/RUN	<b>Change edit/running state</b> ◆ <b>LED is on:</b> Editing program state; it can edit 12 chases,up to 40 steps for each chase. ◆ <b>LED is off:</b> Running the chase.
4	Scanner dimmer selection key	◆ When the indicating light is off, it indicates the data corresponding to the channel slider area scanner. ◆ When the indicating light is on, it indicates the data corresponding to the channel slider area scanner.
5	Distributed control centralized control selection key	◆ When the indicating light is off, it indicates distributed control. ◆ When the indicating light is on, it indicates centralized control.
6	P1-P12 PCH9-PCH16 Number key area	◆ In the program state, it is used to select the number of the chase and to select the number of the controlled scanner.

		<p>In the program state, press this key area once, and the chase number to be edited is selected; press this key area again, and the scanner to be controlled is selected.</p> <ul style="list-style-type: none"> <li>◆ When running the program, it is used to call out the edited chase number.</li> <li>◆ When it is used in coordination with the functional key, it is used to change the selection state of the corresponding channel, or select corresponding scanner number, and call out the 12 independent scenes in No.1 chase.</li> </ul>
7	Dimmer point control area	◆ 206 to 217 channel outputs of the point controlled dimmer.
8	Duplex button area	When applied in the program state and the running program state, it has different function definitions. Please refer to the explanation of the duplex key for details.
9	Page turning 1	Press this key, when the indicating light is on, the slider area is corresponded to CH1—CH8
10	Page turning 2	Press this key, when the indicating light is on, the slider area is corresponded to CH9—CH16
11	Page turning 3	Press this key, when the indicating light is on, the slider area is corresponded to CH17—CH24 (only valid in the dimmer state).
12	Rocker	Used to control the XY scanning channel of the scanner.
13	SPEED. CROSS (Program time control)	<ul style="list-style-type: none"> <li>◆ SPEED potentiometer: adjust the chase pause time in running program, for use in program and running.</li> <li>◆ CROSS potentiometer: adjust the chase cross speed, for use in program and running.</li> <li>◆ The AUTO area in the bottom part of the Potentiometer: used to automatically implement the programmed chase pause time and running speed, the upper part is used to manually and randomly change the program running speed and chase pause time.</li> </ul>
14	LCD 16×2	The state indicates the indicating data; see to the LCD information for details.
15	CH-8 PCH9-16 (Channel data slider area)	Adjust and select the DMX values corresponding to the channels of the scanner and dimmer; used to adjust and select the different functions of the scanner.



## 9. Explanation of the duplex key area

EDIT area	[DELETE]	<p><b>In program state, it is used to delete the chase or chase step, and cancel the setup of the transfer channel.</b></p> <p>Instantly press down: Delete the current chase step.</p> <p>Press down for 3 seconds: Delete the current chase step, and make it an empty program.</p> <p>In the state of [SET X/Y] setting, pressing the [DELETE] key will cancel the X-Y direction channel transfer.</p>
	[ ◀ - ]	In program state, it is used to turn to the previous page, to view the last chase.
	[ + ▶ ]	In program state, it is used to turn to the next page, to memorize the current chase (adding a chase step) or to view the edited chase.
	[SET X/Y]	When just entering the edit state, immediately press [SET X/Y], and according to the prompt on the LCD, select two scanning channels corresponding to the scanner X-Y direction from P1-P8 or PCH9-PCH16, and transfer to control the yellow indicating light with the rocker potentiometer, and then immediately press the [SET X/Y] key again to memorize it and quit.
RUN area	[CLEAR]	<ul style="list-style-type: none"> <li>◆ In any number key selection state in the running mode, press [DELETE], and then immediately clear the indication; it can be repeatedly selected.</li> <li>◆ In the running mode, all channel function data are cleared to zero after pressing this key.</li> </ul>
	[CROSS MODE]	<ul style="list-style-type: none"> <li>◆ <b>Mode 1:</b> When running the program, all the channel data are running with the chase cross time potentiometer control.</li> <li>◆ <b>Mode 2:</b> When running the program, the set X and Y channel data is controlled by the chase cross time potentiometer, and all the other channel data are in the jumping state, so as to prevent the colors and patterns that have not edited or memorized from playing in slow scanning.</li> </ul>
	[SCENE]	When running the chase, press this key, and then immediately select P1-P12, to call out the first 12 scenes in No.1 chase, which are independently presented to be used as special scenes. In order to quit the scene presentation state, please press the [EDIT/RUN] key.
	[RELEASE CHANNELS]	◆ Press this channel release key, in coordination with P1-P8 keys or SHIFT+(PCH9-PCH16) keys, will change the data of channels CH1-CH16, in running the program,

		<p>whether to randomly read the state data corresponding to the potentiometer or to read the state data the program has already set. Press the [RELEASE] key once again, to store the set state and quit.</p> <p>◆ (O indicates the CH1-CH16 channel data is controlled by the manual slider, and F indicates that the channel data automatically runs with the program.)</p>
	[MANUAL]	<p>When running the chase, press [MANUAL], and then press any key of (P1-P12), to select the scanner number to be in the manual state, and then slide the released channel, and then the dimmer effect can be controlled both manually and automatically.</p>

## 10. Explanation of the display information on the LCD

Display	Specific information
DISCO 240 V3.0A	Company name, model and version number
S/N:0020-02-2727**** TEST OK	Sequence Number and test condition
RUN Chase [??] [01] [00.0] [00.0]	<p>Press [EDIT/RUN], the corresponding indicating light will be off, indicating the console is in the running standby.</p> <p>The ?? in Chase [??] indicates the chase number to be input, [01] [00.0] [00.0] are respectively the chase step numbers, the chase pause time, and chase cross speed.</p>
RUN Chase [??] CH[**]→[***]→ or X→[***] Y→[***]	The upper line indicates the running chase, and bottom line indicates the modified channel number and channel data.
RUN SCENE SELECT P1—P12	Press the number key of P1-P12 to select the first 12 scenes that represent the No.1 chase.
EDIT Chase [??] CH [01] [**]	<p>Press [EDIT/RUN], to have the corresponding indicating light on, indicating the console is in the edit state.</p> <p>The ?? in Chase [??] indicates the chase step, which can change with the operation of [◀ -] or [+ ▶] When the final [ ] shows ** in it, it indicates that chase step is the last step in this chase.</p> <p>When [ ] is empty, it indicates that there have been already chase data.</p>
EDIT Chase [??] CH[**] [***] or X→[***]Y→[***]	The upper line represents the chase number to be edited, and the bottom line represents the modified channel number and the channel value.
EDIT Chase [??] SPEED→[***]	The upper line represents the chase number to be edited, and the chase pause time or chase cross time.

or CROSS→[***]	
EDIT Chase [??] STEP [01][**]	Press[EDIT/RUN], to have the corresponding indicating light on, indicating the console is in the edit state. The ?? in Chase[??] represents edited chase number to be run. STEP [01] is the serial number of the chase step, which can change with the operation of[◀ - ]or[+ ▶]When the final [ ] shows** in it, it indicates that chase step is the last step in this chase.
1 2 3 4 5 6 7 8 F F F F F F F F A or F F F F F F F F B	Press [CHANNELS] to show the left interface. The bottom line number indicates the state of the 8 corresponding basic control channels (Channels 1 to 8 are identified with the suffix A, and channels 9 to 16 are identified with the suffix B), and the bottom line F or O respectively indicates whether the channel of the corresponding row is automatic or manual, i.e., whether it is released. Here, F indicates unreleased, which can be changed by pressing the corresponding P1 to P8, or pressing [SHIFT] + (PCH9-PCH16) .
Set: X-Y X: [ ] Y: [ ]	When just entering the editing state, press [SET X/Y] will show the prompt on the left. X: [ ] Y: In the space, the channel number to be transferred to the rocker control can be input by pressing P1-P8 or pressing [SHIFT] + (PCH9-PCH16) , and you can also press [DELETE], to cancel the set transfer channel.
MANUAL: [??] F F F F F F F F A or F F F F F F F F B	In the state of running the chase, pressing[MANUAL], will show the prompt on the left. The[??] in the upper line shows the chase number that is running, and the bottom line shows whether the 1-16 channels (channels 1-8 are identified with suffix A, and channel 9-16 are identified with suffix B) are released. Here, F indicates the corresponding channel is released, and O indicates it has not been released. Press P1-P12 again with select one or more scanners to conduct the manual operation of the released channels. Press [MANUAL] again, will quit the mixed control of manual+ automatic, and then carry out the automatic program.

## 11. The editing of scanner chase

1. Press [BLACK], to turn on the LED;
2. Press [EDLT/RUN], to turn on the LED, and enter the program state;
3. Press any one of the number keys (P1-P12) once, to select the chase number

- to be edited, which is shown in Chase [ ] on the LCD.
4. The press numbers (P1-P12), to select the controlled scanner, and its corresponding LED will be on. If the corresponding indicating light is not on, then that scanner has been selected, so it will not be affected by Step 5.
  5. Slide (CH1-CH8) to adjust the corresponding channel data of the scanner, or press [SHIFT] and slide CH9-CH16 to call out the corresponding scanner effect  
(if you have set X and Y direction scanning channel transfer, then two direct sliding potentiometer sliders will not function. You can control the bottom right rocker potentiometer to get the data).
  6. Repeat steps 4, and 5 to adjust other scanners, so that the needed scanner chase can reach the predefined effect.
  7. Slide [SPEED] and [CROSS] potentiometers, to adjust the chase pause time and chase cross time.
  8. Press [+ ▶], to memorize this chase effect, and enter the next step of editing.(Press [◀ - ], can view the last chase, repeat modification in steps 4,5,6 and 7, and press [+ ▶] again to store it).
  9. Repeat steps 4 to 8, to edit other chase.
  10. Press [EDIT/RUN], to have the corresponding indicating light on; memorize it and then quit the editing state, to enter the running state.
  11. Repeat steps 2 to 10, to edit other chase.

## **12. Running of scanner chases**

1. Press [EDIT/RUN], to have the corresponding LED on.
2. Press number keys (P1-P12), to select the chase number, and make it run; if that chase has not been edited, then the corresponding LED will not be on when that key number is pressed.
3. Adjust [SPEED] and [CROSS] potentiometers, to change the inter-chase pause time and the chase cross speed; if the [SPEED] or [CROSS]

- potentiometer is in the bottom AUTO area, then the chase pause time and chase cross time that had already been edited will be run.
4. Press [CROSS MODE], to change the running mode; see 9.explanation of the duplex key area for details.
  5. If you want to carry out the mixed running program of manual and automatic, you can set the running according to the following steps.
    - a). First, release the channel: Press [CHANNELS], and then press (P1-P8) (or press [SHIFT], and then press PCH9-PCH16), to release the corresponding channel, and F will be changed to O; at last, press [CHANNELS], to memorize it and quit. (F: indicates that the corresponding channel will not take manual data in chase running, and is controlled by a programmed chase. O: indicates the corresponding channel is not controlled by the chase in chase running, and it will take manual slider data).
    - b). Select the scanner that will run the release channel: Press [MANUAL], and then press (P1-P12), to select the scanner light to be manually controlled. Randomly push the corresponding released potentiometer slider to carry out mixed running program of manual + automatic, then press [MANUAL] to quit the manual option.
  6. Press [BLACK] can make pause/start selections for the running chase; when LED corresponding to the key is on, then output is paused, and when the LED is off, then the output is run normally.

### **13. Special scene presentation**

In the state of running chase (i.e., the indicating light corresponding to [RUN/EDIT] is off), press [RUN SCENE], and then press any key of P1-P12, will call out the first 12 scenes in the programmed No. 1 chase. Therefore, we suggest that in that in program state, the first 12 scenes in No. 1 chase should be specially defined, which can make some special effects.

## **14. How to set and cancel the rocker potentiometer**

Set the rocker potentiometer settings: Press [RUN/EDIT], to light the indicating light, and then press [SET X/Y] immediately; according to the prompt on the LCD, select two scanning channels corresponding to the scanner X and Y direction from (P1-P8) (or from PCH9-PCH16 by pressing SHIFT), shift to use the rocker potentiometer to control the green indicating light, and the light is on immediately. In case of wrong input, press [DELETE] to cancel the input, and input the correct corresponding channel, and then press [SET X/Y] again to memorize it and quit.

Cancel rocker potentiometer settings: In the state of [SET X/Y], press [DELETE] to clear the input data, and the green indicating light turns off immediately; and then press [SET X/Y] again to memorize it and quit.

## **15. Conventional dimmer control**

Point control: Press P13-P24 to control the dimmer 206-217 channels, and when the indicating light is on, the output is 100%, and when the indicating light is off, the outputs is 0%.

Distributed control: In the state of non-programming, press SCAN/LIGHT to make the indicating light turn on; enter the dimmer state, select the channel page of dimmer control by pressing SA/SB/SC, and push the different sliders in the slider area to adjust the dimmer output.